

GLOBAL SERIES

Totally Enclosed Fan Cooled
& Open Drip Proof

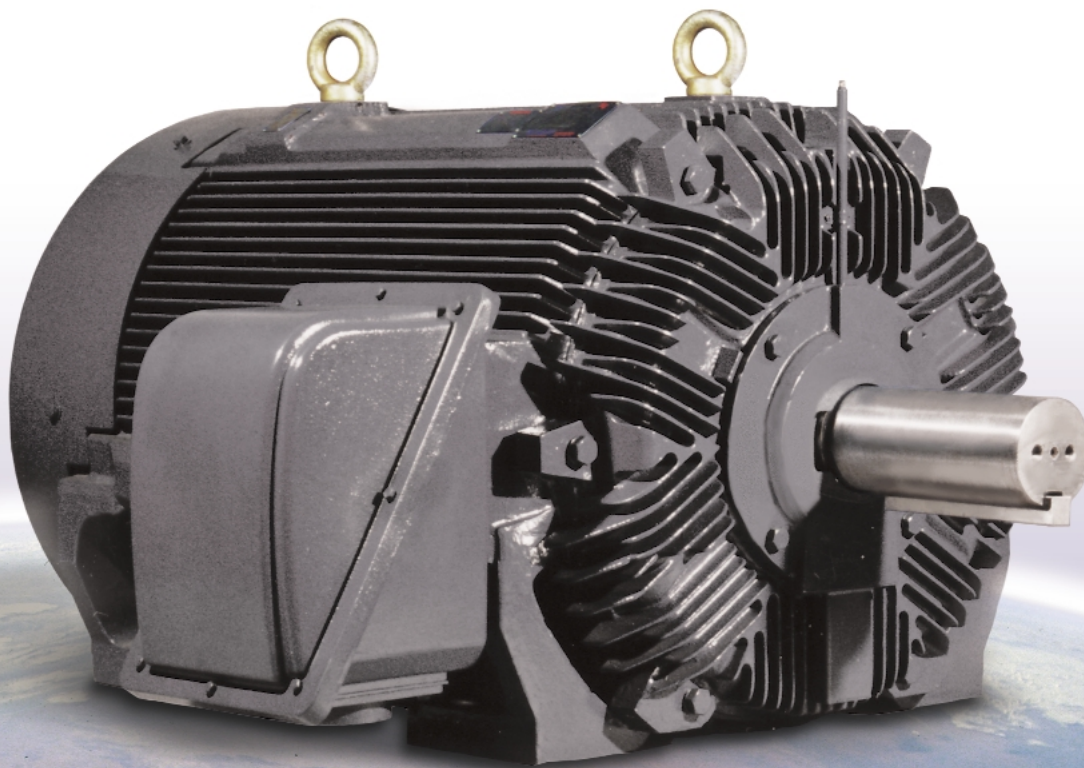

 **TECO** - Westinghouse 

M O T O R C O M P A N Y

Construction Features

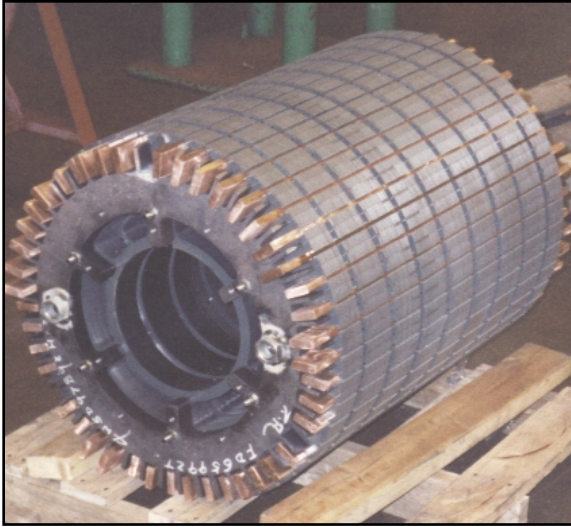

Rotor:

All Global Series motors have high quality steel laminations and copper/copper alloy induction brazed rotor bars* and end rings. This provides a high degree of strength and thermal capacity.

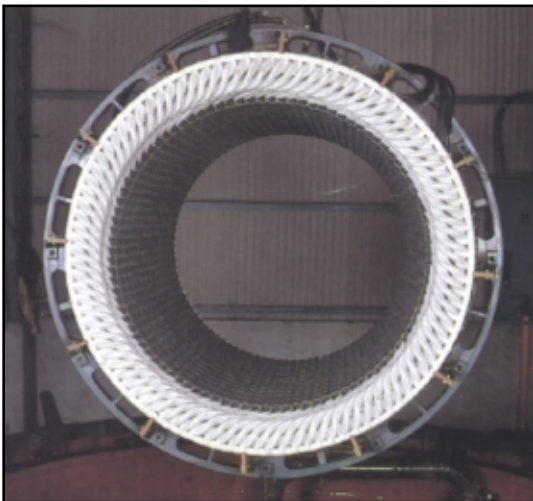
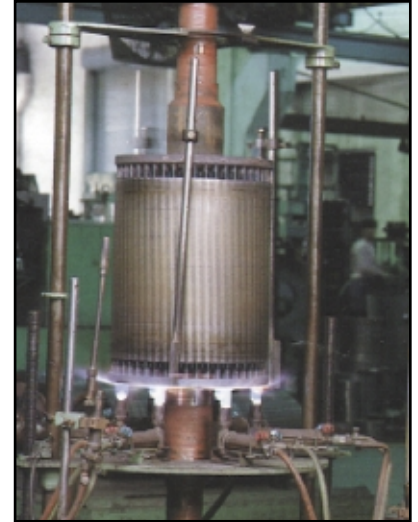

Insulation:

Low voltage models feature a Class F non-hygroscopic insulation system using a two cycle dip and bake varnish process. Medium voltage models feature Class F mica tape insulation which undergoes a two cycle VPI treatment using a high quality, solventless epoxy resin.

Stator Core and Windings:

All Global Series motors include high grade, low loss steel for the stator core. Low voltage models have random-wound stator windings that are securely braced using end turn lacing prior to the varnish process. Medium voltage motors are form-wound and fitted with insulated bracing rings and felt inserts prior to the VPI treatment.

* Die cast aluminum rotor design for TEFC-Low Voltage, 5000 frame, 2P, 4P, and 6P.



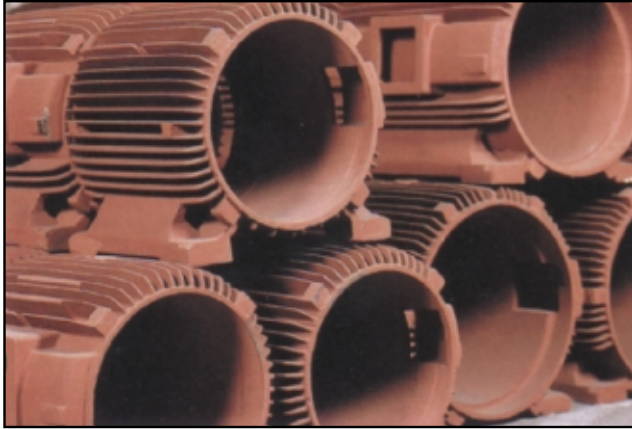

Frame and End Brackets

All ratings feature high quality cast iron frames, end brackets and conduit boxes.

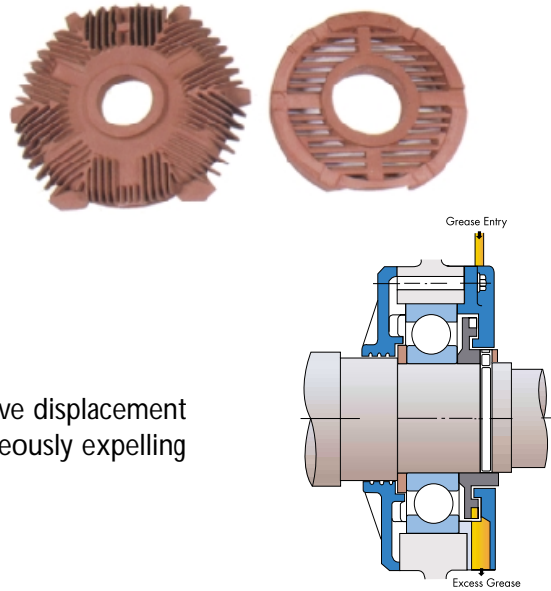

Bearings and Lubrication:

All ratings use oversized, vacuum de-gassed bearings. The positive displacement re-greasing system allows for adding new grease while simultaneously expelling used grease.

TEFC-MEDIUM VOLTAGE

HP	Full Load	Frame Size	EFFICIENCY			POWER FACTOR			CURRENT		TORQUE				Rotor WR ² LB FT ²	NEMA Code Letter
			Full Load	3/4 Load	1/2 Load	Full Load	3/4 Load	1/2 Load	Full Load	Locked Rotor	Full Load LB FT	Locked Rotor %FLT	Pull Up %FLT	Break Down %FLT		
200	1175	5007C	92.4	90.2	87.5	81.5	80.0	74.0	49.8	290	893	200	160	250	136	G
	875	5009C	92.4	90.2	87.5	78.5	74.0	64.0	51.7	290	1200	125	100	210	242	G
250	3575	5007A	93.0	91.0	88.5	90.2	88.5	84.0	55.9	365	367	110	90	220	54	G
	1780	5007C	93.0	91.0	88.5	87.5	84.0	78.5	57.6	365	737	200	160	250	129	G
	1180	5009C	93.0	91.0	88.5	82.5	80.0	74.0	61.1	365	1112	200	160	250	171	G
	875	5808B	93.0	91.7	89.5	78.5	74.0	64.0	64.2	365	1500	125	100	210	418	G
300	3580	5009A	93.6	92.4	89.5	90.2	87.5	84.0	66.6	440	440	110	90	220	66	G
	1785	5009C	93.6	91.7	88.5	88.5	85.5	80.0	67.9	440	882	200	170	250	173	G
	1185	5808B	93.6	91.7	89.5	84.0	81.5	75.5	71.5	440	1329	200	160	250	350	G
	880	5808B	93.6	91.7	90.2	80.0	75.5	66.0	75.1	440	1790	125	100	210	538	G
350	3580	5808A	93.6	91.7	89.5	90.2	87.5	84.0	77.7	510	513	110	90	210	107	G
	1785	5808B	93.6	91.7	88.5	88.5	85.5	80.0	79.2	510	1029	200	160	250	242	G
	1185	5808B	93.6	91.7	89.5	84.0	81.5	75.5	83.4	510	1550	200	160	250	403	G
	880	5810B	93.6	91.7	89.5	80.0	75.5	66.0	87.6	510	2088	120	100	200	619	G
400	3580	5808A	94.1	92.4	89.5	91.0	88.5	84.0	87.5	580	586	105	85	210	121	G
	1785	5808B	94.1	92.4	89.5	89.5	86.5	81.5	89.0	580	1176	200	160	250	274	G
	1185	5810B	94.1	92.4	90.2	85.5	82.5	77.0	93.2	580	1772	200	160	250	455	G
	885	6806B	93.6	92.4	90.2	81.5	77.0	66.0	98.2	580	2373	115	95	200	956	G
450	3585	6806A	94.1	92.4	89.5	91.0	89.5	84.0	98.5	650	659	105	85	210	244	G
	1785	5810B	94.1	92.4	89.5	89.5	86.5	80.0	100.0	650	1323	200	160	250	302	G
	1185	5810B	94.1	92.4	90.2	85.5	82.5	77.0	105.0	650	1993	200	160	250	502	G
	885	6806B	93.6	92.4	90.2	82.5	77.0	66.0	110.0	650	2669	115	95	200	1040	G
500	3585	6806A	94.5	93.0	91.0	91.7	89.5	86.5	108.0	725	732	105	85	200	269	G
	1785	5810B	94.5	93.0	91.0	90.2	86.5	80.0	110.0	725	1470	200	160	250	332	G
	1185	6806B	94.5	92.4	90.2	85.5	82.5	77.0	116.0	725	2215	200	160	250	802	G
	885	6806B	94.1	93.0	91.0	82.5	80.0	72.0	121.0	725	2966	110	90	190	1084	G
600	1785	6806B	94.5	93.0	91.0	90.2	86.5	81.5	132.0	885	1764	200	160	250	554	G
	1185	6806B	94.5	93.0	91.7	86.5	84.0	78.5	138.0	885	2658	200	160	250	876	G
	885	6808B	94.1	93.0	91.0	84.0	81.5	74.0	143.0	885	3559	110	90	190	1246	G
700	1785	6806B	95.0	93.0	91.0	90.2	86.5	81.5	153.0	1025	2059	200	160	250	670	G
	1185	6808B	95.0	93.6	91.7	86.5	84.0	78.5	160.0	1025	3101	200	160	250	1017	G
800	1785	6808B	95.0	93.0	91.0	90.2	87.5	84.0	175.0	1180	2353	200	160	250	660	G

- Note: 1. Current based on 2300V.
 2. The above are typical values based on test.
 3. Test method: A. ANSI/IEEE standard 112-1996 Method B and full voltage starting for motors not over 300HP.
 B. ANSI/IEEE standard 112-1996 Method E1 and full voltage starting for the others.
 4. Data subject to change without notice.



ODP/WPI-MEDIUM VOLTAGE

HP	Full Load	Frame Size	EFFICIENCY			POWER FACTOR			CURRENT		TORQUE				Rotor WR ² LB Ft ²	NEMA Code Letter
			Full Load	3/4 Load	1/2 Load	Full Load	3/4 Load	1/2 Load	Full Load	Locked Rotor	Full Load LB FT	Locked Rotor % FLT	Pull Up % FLT	Break Down % FLT		
200	1170	5007C	91.7	91.0	89.5	81.5	78.5	74.0	50.1	290	896	100	80	200	120	G
	870	5009B	91.7	91.0	89.5	78.5	74.0	68.0	52.0	290	1206	100	80	200	204	G
250	1170	5007C	92.4	91.7	90.2	82.5	80.0	74.0	61.4	365	1120	110	90	200	150	G
	870	5009B	92.4	91.7	90.2	78.5	74.0	68.0	64.5	365	1507	110	90	200	219	G
300	1775	5007C	93.0	92.4	91.0	88.5	85.5	80.0	68.3	440	886	105	85	200	121	G
	1175	5009B	93.0	92.4	91.0	84.0	80.0	74.0	71.9	440	1339	110	90	200	169	G
	875	5808B	93.0	92.4	91.0	80.0	75.5	70.0	75.5	440	1798	100	80	200	425	G
350	3565	5007A	93.0	92.4	91.0	90.2	88.5	85.5	78.1	510	515	90	75	200	46	G
	1775	5007C	93.0	92.4	91.0	88.5	85.5	80.0	79.6	510	1034	105	85	200	141	G
	1175	5009B	93.0	92.4	91.0	84.0	80.0	74.0	83.9	510	1562	105	85	200	208	G
	875	5808B	93.0	92.4	91.0	80.0	75.5	70.0	88.1	506	2097	105	85	200	509	G
400	3565	5009A	93.6	93.0	91.7	91.0	87.5	84.0	87.9	580	588	100	80	200	52	G
	1775	5009B	93.6	93.0	91.7	89.5	86.5	81.5	89.4	580	1182	100	80	200	161	G
	1175	5808B	93.6	93.0	91.0	85.5	82.5	77.0	93.6	580	1785	105	85	200	311	G
	875	5808B	93.0	92.4	91.0	81.5	77.0	70.0	98.8	580	2397	105	85	200	548	G
450	3570	5808A	93.6	93.0	91.7	91.0	87.5	84.0	98.9	650	661	85	70	200	82	G
	1780	5808B	93.6	93.0	91.7	89.5	86.5	81.5	101.0	650	1326	100	80	200	193	G
	1175	5808B	93.6	93.0	91.0	85.5	82.5	77.0	105.0	650	2008	100	80	200	335	G
	875	5810B	93.0	92.4	91.7	82.5	80.0	72.0	110.0	650	2696	100	80	200	590	G
500	3570	5808A	94.1	93.6	91.7	91.7	88.5	84.0	109.0	725	734	100	80	200	91	G
	1780	5808B	94.1	93.6	91.7	90.2	87.5	84.0	110.0	725	1473	100	80	200	222	G
	1180	5808B	94.1	93.6	91.7	85.5	82.5	77.0	116.0	725	2222	100	80	200	372	G
	880	5810B	93.6	93.0	91.7	82.5	80.0	72.0	121.0	720	2979	100	80	200	740	G
600	3575	5808A	94.1	93.6	91.7	91.7	89.5	86.5	130.0	880	880	80	65	190	109	G
	1780	5808B	94.1	93.6	91.7	90.2	87.5	84.0	132.0	880	1767	100	80	190	266	G
	1180	5810B	94.1	93.6	91.7	86.5	84.0	80.0	138.0	880	2666	90	75	190	446	G
	880	6806B	93.6	93.0	91.7	84.0	81.5	74.0	143.0	870	3575	90	75	190	977	G
700	3575	5810A	94.5	93.6	91.7	91.7	89.5	86.5	151.0	1020	1027	80	65	190	127	G
	1780	5808B	94.5	93.6	91.7	90.2	87.5	84.0	154.0	1020	2062	90	75	190	310	G
	1180	5810B	94.5	93.6	91.7	86.5	84.0	81.5	160.0	1020	3110	90	75	190	465	G
	880	6808B	94.1	93.6	91.7	84.0	81.5	80.0	166.0	1015	4171	90	75	190	1135	G
800	3580	5810A	94.5	93.6	91.7	91.7	89.5	86.5	173.0	1170	1172	80	65	190	145	G
	1780	5810B	94.5	93.6	91.7	90.2	87.5	84.0	176.0	1170	2356	90	75	190	319	G
	1180	6806B	94.5	93.6	91.7	86.5	84.0	81.5	183.0	1170	3555	90	75	190	713	G
	880	6808B	94.1	93.6	91.7	84.0	81.5	80.0	190.0	1165	4767	85	70	185	1166	G
900	1785	5810B	95.0	94.1	93.0	90.2	88.5	85.5	197.0	1315	2644	90	75	185	398	G
	1185	6806B	94.5	93.6	92.4	86.5	84.0	81.5	206.0	1315	3982	90	75	185	802	G
1000	1785	6806B	95.0	94.1	93.0	90.2	88.5	85.5	219.0	1450	2937	90	75	185	586	G
	1185	6808B	95.0	94.1	93.0	86.5	84.0	82.5	228.0	1450	4425	85	70	185	875	G
1250	1785	6808B	95.0	94.1	93.0	90.2	88.5	85.5	273.0	1815	3672	90	75	185	732	G

- Note:
1. Current based on 2300V.
 2. The above are typical values based on test.
 3. Test method: A. ANSI/IEEE standard 112-1996 Method B and full voltage starting for motors not over 300HP.
B. ANSI/IEEE standard 112-1996 Method E1 and full voltage starting for the others.
 4. Data subject to change without notice.

Additional Features

All medium voltage motors include 100Ω Platinum Stator RTD's, (2 pcs per phase) and 120V 1Ø Space Heaters as standard features.

Ratings and Standards

Power Supply:

AC, Three phase, 60Hz available for 460V, 575V, and 2300/4160V systems.

Output Range:

Low voltage motors range from 200-500HP. Medium Voltage motors range from 200-1250HP.**

Speed Range:

3600-900RPM (2-8 Pole).

Enclosure:

Available in TEFC (IP44) or ODP (IP22)/WPI enclosure.

Duty Rating:

Continuous rating with 1.15 service factor.

Performance:

All Global Series motors are designed to meet or exceed NEMA Design B or C torque requirements.

Testing:

Routine testing is performed in accordance with NEMA MG-1-12 and IEEE 112 Method B for motors through 300HP; and Method E1 for motors larger than 300HP.

** Please refer to factory for NEMA T-frame, medium voltage motors

TEFC-LOW VOLTAGE

HP	Full Load	Frame Size	EFFICIENCY			POWER FACTOR			CURRENT		TORQUE				Rotor WR ² LB FT ²	Code Letter	Approx Weight LBS
			Full Load	3/4 Load	1/2 Load	Full Load	3/4 Load	1/2 Load	Full Load	Locked Rotor	Full Load LB FT	Locked Rotor %FLT	Pull Up %FLT	Break Down %FLT			
200	885	5007C	94.1	92.4	91.0	84.0	77.0	68.0	237	1450	1188	120	100	220	230	G	3550
250	1180	5007C	94.1	92.4	91.0	86.5	82.5	74.0	288	1825	1113	200	160	220	205	G	3400
	885	5009C	94.5	92.4	91.0	84.0	77.0	68.0	295	1825	1485	110	90	200	275	G	4000
300	3580	5007A	94.5	92.4	91.0	91.0	88.5	85.5	327	2200	440	100	85	250	52	G	3250
	1775	5007C	94.5	93.0	91.0	89.5	86.5	81.5	332	2200	887	200	160	220	132	G	3200
	1180	5009C	94.1	92.4	91.0	86.5	82.5	74.0	345	2200	1335	200	160	220	240	G	4100
	885	5806B	94.5	92.4	91.0	84.0	77.0	68.0	353	2200	1782	100	80	200	456	G	4850
350	3580	5009A	94.5	92.4	91.0	91.0	88.5	86.5	381	2550	514	110	90	250	58	G	3350
	1775	5009C	94.5	93.0	91.0	90.2	86.5	81.5	384	2550	1035	200	160	220	154	G	3650
	1183	5806B	94.5	93.0	91.0	86.0	81.5	75.0	403	2550	1553	200	160	240	340	G	4600
	885	5808B	94.5	92.4	91.0	84.0	77.0	68.5	413	2550	2078	100	80	200	540	G	5750
400	3580	5808A	94.5	93.0	90.2	91.7	90.2	86.5	432	2900	587	100	80	250	116	G	4450
	1780	5806B	94.5	93.0	90.2	90.2	87.5	81.5	439	2900	1180	200	160	230	270	G	4200
	1183	5808B	94.5	93.0	90.2	86.0	82.0	75.0	461	2900	1775	200	160	240	375	G	5100
	888	5808B	94.5	92.4	90.2	84.0	77.5	68.5	472	2900	2364	100	80	220	572	G	5550
450	1780	5808B	94.5	93.0	91.0	90.2	87.5	82.5	494	3250	1327	200	160	230	303	G	4850
	1183	5808B	94.5	93.0	91.0	86.0	82.5	75.0	518	3250	1997	200	160	240	405	G	5300
500	1780	5808B	94.5	93.0	91.0	90.5	88.0	82.5	547	3625	1475	200	160	230	340	G	5300
	1183	5808B	94.5	93.0	91.0	86.5	82.5	76.0	573	3625	2219	200	160	240	435	G	5650

- Note:
1. Current based on 460V.
 2. The above are typical values based on test.
 3. Test method: A. ANSI/IEEE standard 112-1996 Method B and full voltage starting for motors not over 300HP.
B. ANSI/IEEE standard 112-1996 Method E1 and full voltage starting for the others.
 4. Data subject to change without notice.



For more than a century, TECO-Westinghouse motors have been recognized as industry leaders in dependability and quality. TECO-Westinghouse Global Series motors are

designed and manufactured to the highest standards using top quality materials and superior workmanship. Our proven record of reliability is your assurance that TECO-Westinghouse Global Series motors are built to last and operate efficiently in most industrial applications.

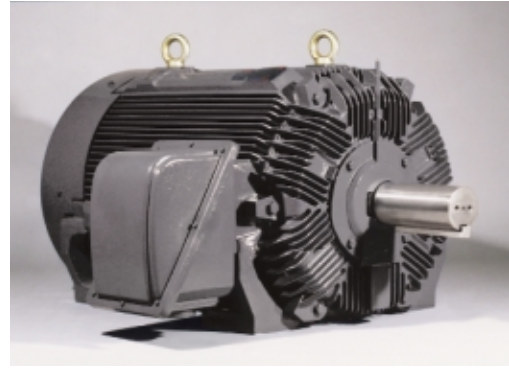

ODP-LOW VOLTAGE

HP	Full Load	Frame Size	EFFICIENCY			POWER FACTOR			CURRENT		TORQUE				Rotor WR ² LB FT ²	NEMA Code Letter	Approx Weight LBS
			Full Load	3/4 Load	1/2 Load	Full Load	3/4 Load	1/2 Load	Full Load	Locked Rotor	Full Load LB FT	Locked Rotor %FLT	Pull Up %FLT	Break Down %FLT			
250	880	5007C	93.6	91.7	89.5	84.0	77.0	66.0	298	1825	1490	110	90	200	238	G	3630
300	1180	5007C	94.5	93.0	90.2	86.5	84.0	80.0	344	2200	1336	160	130	200	177	G	3100
	880	5009B	94.1	92.4	89.5	84.0	80.0	72.0	355	2200	1788	100	80	200	256	G	3850
350	1780	5007C	95.0	93.6	91.0	90.2	85.5	81.5	382	2550	1031	180	140	220	111	G	2860
	1180	5009B	94.5	93.0	90.2	86.5	84.0	80.0	401	2550	1558	130	100	200	200	G	3530
	880	5808B	93.6	91.7	89.5	84.0	80.0	72.0	417	2550	2086	100	80	200	377	G	4300
400	1780	5009B	95.0	93.6	91.0	90.2	85.5	81.5	437	2900	1179	180	140	220	132	G	3190
	1180	5806B	95.0	93.6	91.0	86.5	84.0	80.0	455	2900	1782	140	110	220	356	G	3560
	880	5808B	94.5	93.0	89.5	84.0	80.0	72.0	472	2900	2384	100	80	200	432	G	4550
450	3575	5009A	94.1	92.4	89.5	91.7	89.5	85.5	488	3250	662	100	80	200	45	G	3600
	1785	5806B	95.0	93.6	91.0	90.2	85.5	81.5	491	3250	1322	170	140	220	222	G	3830
	1185	5808B	95.0	93.6	91.0	86.5	84.0	80.0	513	3250	1992	200	160	250	438	G	4320
500	3575	5808A	94.5	93.0	90.2	91.7	89.5	85.5	540	3625	734	100	80	200	110	G	4180
	1785	5806B	95.0	93.6	91.0	90.2	85.5	81.5	547	3625	1469	200	160	250	270	G	3960
	1185	5808B	95.0	93.6	91.0	86.5	84.0	80.0	570	3625	2213	160	130	250	420	G	4840

- Note: 1. Current based on 460V.
 2. The above are typical values based on test.
 3. Test method: A. ANSI/IEEE standard 112-1996 Method B and full voltage starting for motors not over 300HP.
 B. ANSI/IEEE standard 112-1996 Method E1 and full voltage starting for the others.
 4. Data subject to change without notice.



M O T O R C O M P A N Y

USA
 P.O. Box 277 (78680-0277)
 5100 N. IH 35
 Round Rock, Texas 78681
 1-800-451-8798

 YOUR INDUSTRIAL SOLUTIONS
POWERHOUSE
www.tecowestinghouse.com

CANADA
 18060-109 Avenue
 Edmonton, Alberta T5S 2K2
 West: 1-800-661-4023
 East: 1-800-268-4770